

RDS

RDS

**RAILWAY
DEFORMATION SYSTEM**



SIGGEO
TRANSVERSE RDS
Digital Gauge

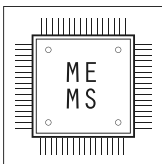

RDS

RAILWAY DEFORMATION SYSTEM

The RDS (Railway Deformation System) is a system designed and developed for the automatic monitoring of railways.

RDS consists of a digital MEMS tiltmeter mounted parallel or transverse to the track. Micro-prisms can be installed on RDS-T gauges to integrate the system with optical monitoring.

RDS components are used to monitor settlement, heave, and twist of the track. The system is designed to be used on active tracks to ensure railway safety.

APPLICATIONS

- Monitors for possible deformations caused by nearby excavations
- Monitors for stability of temporary supports for railway tracks
- Monitors for safe operation in areas of possible settlement or heave

FEATURES

- Provides high accuracy with digital MEMS sensors
- Accommodates thermal expansion by telescopic joint
- Tolerates shock up to 20000 g
- Removes easily when reballasting is required

 Meets the essential requirements of the EMC Directive 2014/30/UE

TECHNICAL SPECIFICATIONS

PRODUCT CODE	0S7RDSHDT02	0S7RDSHDL00
Model	RDS-T: Transverse RDS gauge The RDS-T consists of an aluminum sensor body with a steel anchor plate. It can be installed on concrete or wooden ties (sleepers). It is supplied with two 2 meter cables and waterproof connectors. The RDS-T is suitable for monitoring of railway tracks with temporary support (i.e. Essen method).	RDS-L: Longitudinal RDS gauge The RDS-L consists of a MEMS tilt sensor mounted inside square-section aluminum tubing. The bar includes telescoping joint at one end, an optical target, and an anchor plate. The anchor plate is suitable for concrete ties (sleepers), and has extra mounting holes to allow for up to 150 mm variations in the distance between ties.
Measurement principle	uniaxial MEMS digital inclinometer	uniaxial MEMS digital inclinometer
Measuring range	±10° (±5° on request)	±10° (±5° on request)
Sensor repeatability	0.0013°	0.0013°
Sensor resolution	0.00056°	0.00056°
Sensor mechanical bandwidth	18 Hz	18 Hz
Sensor stability @ 30 days ⁽¹⁾	<0.007°	<0.007°
Sensor accuracy:		
Lin. MPE ⁽²⁾	<± 0.02% FS (±0.020 mm with ±10° range)	<± 0.02% FS (<±0.070 mm/m with ±10° range)
Pol. MPE ⁽²⁾	<± 0.01% FS (±0.010 mm with ±10° range)	<± 0.01% FS (<±0.035 mm/m with ±10° range)
Power supply	from 8 to 28 Vdc	from 8 to 28 Vdc
Signal output ⁽³⁾	RS485, Modbus RTU ⁽⁵⁾	RS485, Modbus RTU ⁽⁵⁾
Sensitivity ⁽⁴⁾	see calibration report	see calibration report
A/D converter	32 bit, precision 38-kSPS	32 bit, precision 38-kSPS
Average consumption	4.3 mA @ 24 Vdc, 8.0 mA @ 12 Vdc	4.3 mA @ 24 Vdc, 8.0 mA @ 12 Vdc
Temperature operating range	-30° to +70°C	-30° to +70°C
Internal temperature sensor:	Embedded on electronic board	Embedded on electronic board
- measuring range	- 40°C to +125°C	- 40°C to +125°C
- resolution	0.01 °C	0.01 °C
- accuracy	±1°C with temperature range -10°C to +85°C	±1°C with temperature range -10°C to +85°C
IP class	IP67	IP67
Connectors	two 5-pin connectors, waterproof up to 1.0 MPa	two 5-pin connectors, waterproof up to 1.0 MPa
Sensor cables (included)	two cables, 2 m each ⁽⁵⁾	two cables, 20 cm each
Max cable length to logger	refer to F.A.Q.#073 on Sisgeo web site	refer to F.A.Q.#073 on Sisgeo web site

(1) Measured stability after 30 days, reference reading taken 24 hours after installation. Test performed under nearly-repeatability conditions.

(2) MPE is the Maximum Permitted Error on the measuring range (FSR). In the Calibration Report, the accuracies of the gauge are calculated using both linear regression (≤ Lin. MPE) and polynomial correction (≤ Pol. MPE)

(3) RS485 not-optoisolated Modbus communication with RTU Protocol. Default output is sen alpha, other units available are degree, mm/m or inch/feet (to be requested at order). Sisgeo Modbus protocol manual is available for download here: https://www.sisgeo.com/uploads/manuali/SISGEO_digitized_instruments_-_Modbus_protocol_specification_EN_04_17.pdf.

(4) Sensitivity is a specific parameter different for every gauge. The sensitivity is calculated during gauge calibration test and inserted into the Calibration Report.

(5) 5 m, 10 m and 15 m cables available on request

RDS-T PHYSICAL FEATURES

PRODUCT CODE	0S7RDSHDT02
Sensor body length	245 mm (9.6")
Total height	76.6 mm (3")
Installation plate	295 x 64 mm (11.6" x 2.5")
Materials	Aluminum body and steel plate

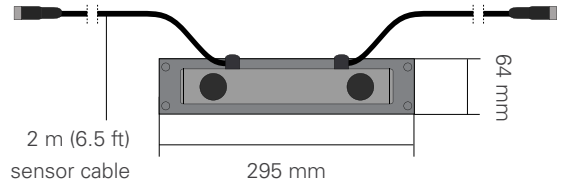

RDS-L PHYSICAL FEATURES

PRODUCT CODE	0S7RDSHDL00
Length (L)	1000, 2000 or 3000 mm (L) (3.25 ft, 6.5 ft, 9.8 ft)
Total height	86 mm (3.4")
Anchor plate	200 x 200 mm (8 x 8")
Materials	aluminum bar and steel plate

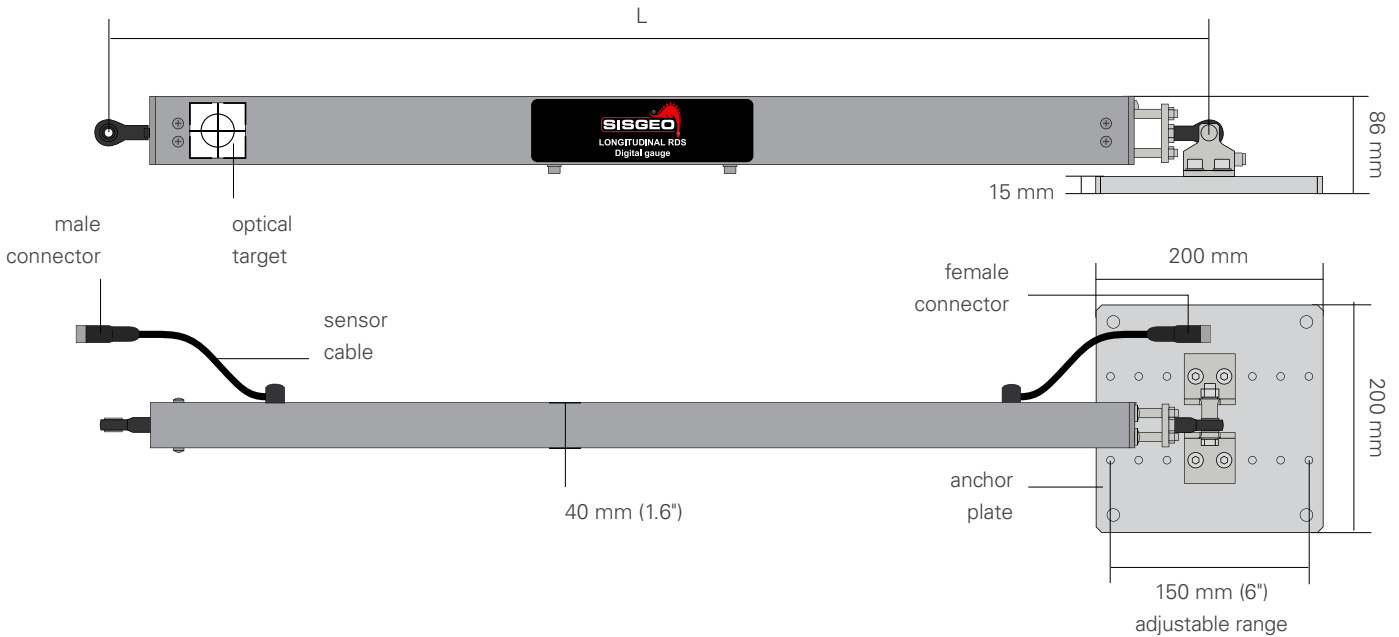

TELESCOPIC JOINT

Sisgeo developed a special telescoping joint for the RDS-L tubing. It accommodates thermal expansion of the aluminum bar to eliminate possible bending that would affect the sensor readings.

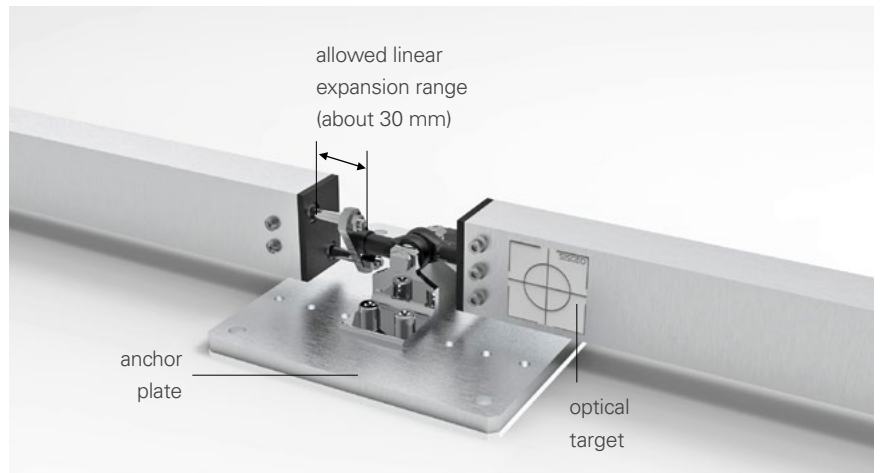

RDS - L : LONGITUDINAL DEFORMATIONS

The RDS-L gauges are installed in continuous chain to monitor the longitudinal level of the tracks. The gauge mounting plates are anchored to the ties with screws or with special resin.

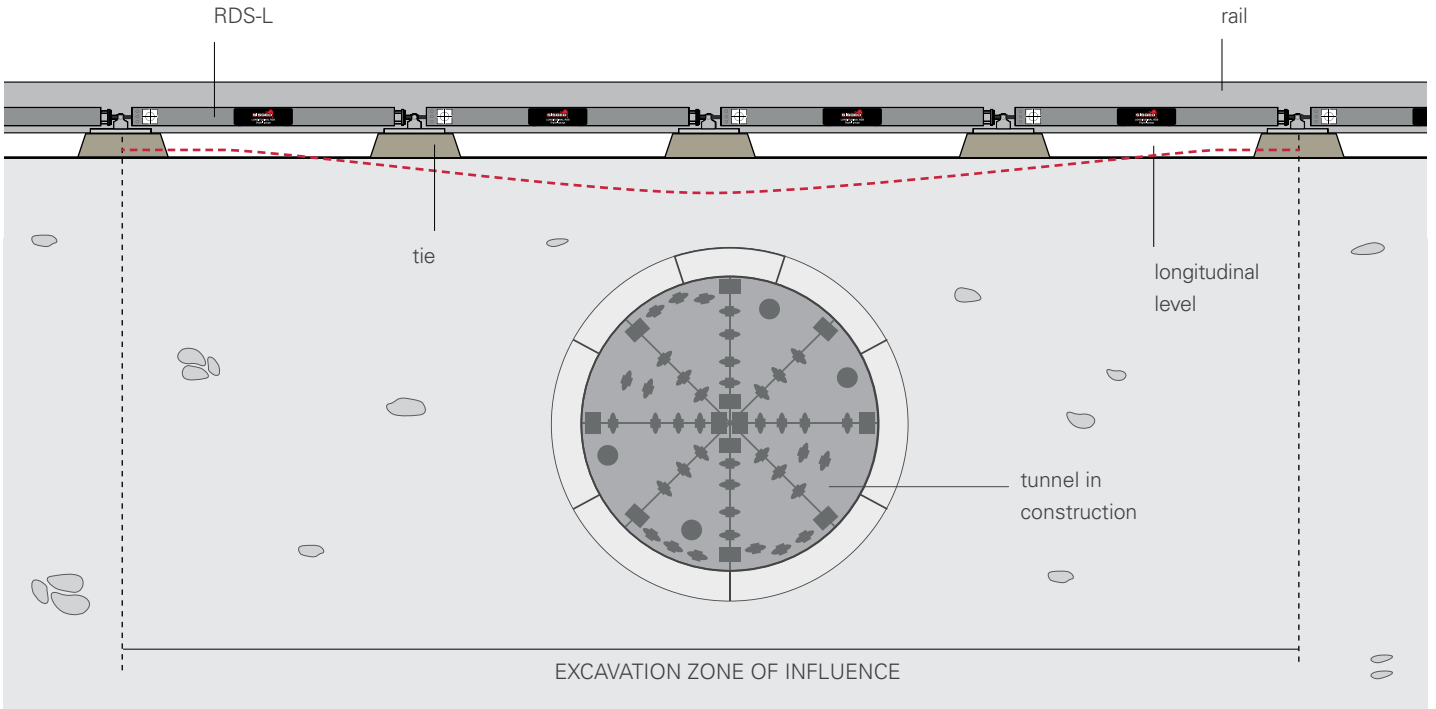

RDS - T : TRANSVERSE DEFORMATION

The RDS-T are installed to monitor the inclination of the ties and consequently the cant (or "skew") of the railway. The twisting is usually expressed in ‰ as the relative inclination of one rail Vs the other.

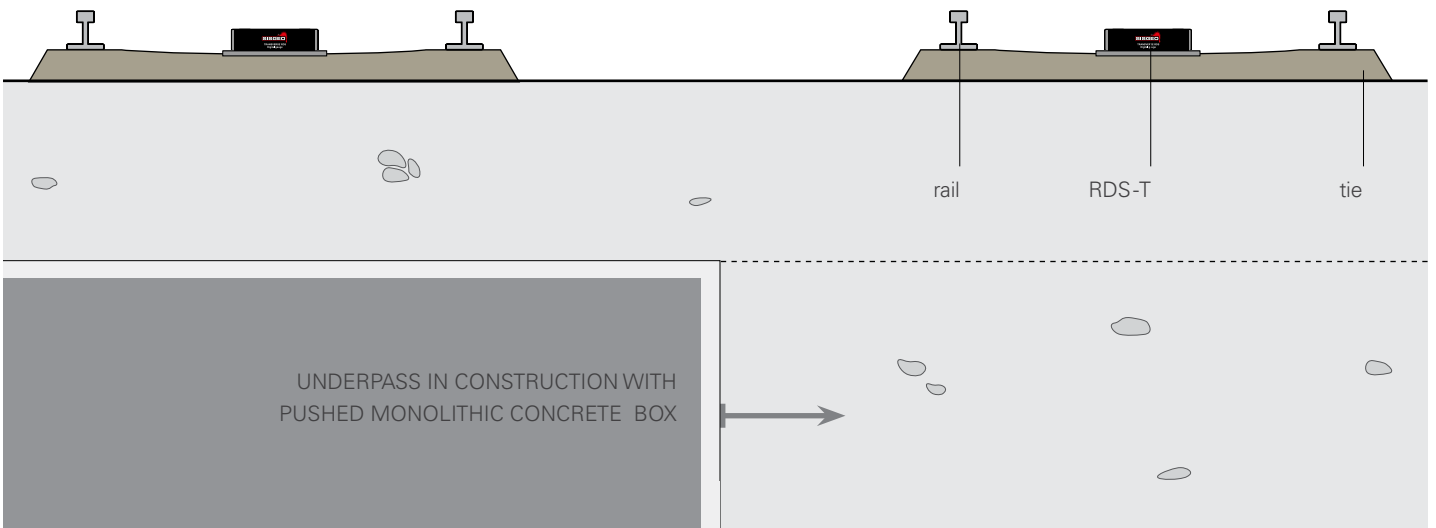

RDS SYSTEM

The RDS system consists of a number of RDS-L and RDS-T gauges spanning the entire area where track deformation may occur. RDS-L are installed in continuous chain, and RDS-T are installed at preset intervals (usually 1 m, 3 m or 9 m). All the gauges connected to an RS-485 bus by waterproof 5-pin connectors. The RS-485 bus cable is terminated in the junction box included with the RDS terminal kit (0S7RDSTER5M). A digital cable 0WE606IPDZH carries the data from the junction box to an OMNIAlog datalogger. The OMNIAlog datalogger collects and sends RDS system data to an SQL database through GSM/GPRS modem, 3G/VPN router, fiber optic cable, radio or satellite interface. The web platform WMS (Web Monitoring System) validate, processes, converts, manages and publishes data on dedicated web pages, as requested by the user. RDS gauges are developed for easily removal when rebalasting is required or when the system must be moved to a different location. The rugged RDS system tolerates hard weather and wide temperature ranges. All the components have IP67 protection minimum and a working temperature range of -30°C to +70°C . If the railway section to be monitored is very long, small errors may accumulate. In that case, the OPTICAL - RDS integrated system is recommended.

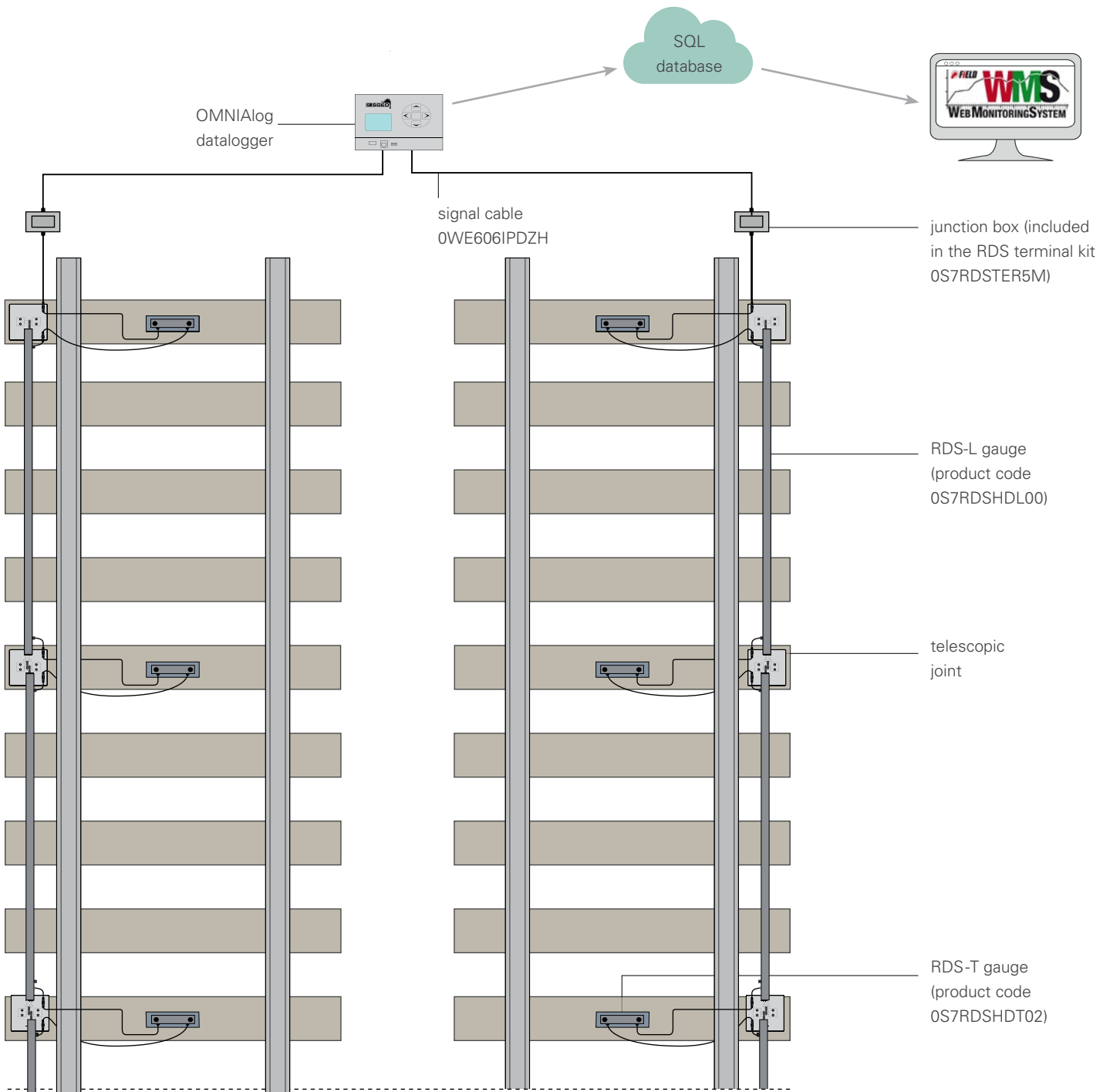

OPTICAL-RDS INTEGRATED SYSTEM

The OPTICAL - RDS integrated system consists of a number of RDS-T gauges, each with a micro prism for optical monitoring. The RDS-T gauges are usually installed on the sleepers at 1 m, 3 m or 9 m intervals. Longitudinal deformations are measured with an high-accuracy (0.5") robotic total station, able to detect the vertical position of the micro prism and, with processing, the settlement or heave of the tracks. Transverse deformations are monitored with the RDS-T gauges, all connected to an RS-485 bus by waterproof 5-pin connectors, and then to the OMNIAlog through a junction box and digital cable. Both the robotic total station and the OMNIAlog data logger collect and send data to an SQL database through GSM/GPRS modem, 3G/VPN router, fiber optic cable, radio or satellite interface. The web platform WMS (Web Monitoring System) validates, processes, converts, manages and publishes data on dedicated web pages, as requested by the customer. RDS-T gauges are developed for easily removal when reballasting is required or when the system must be moved to a different location. The OPTICAL - RDS integrated system is recommended when the monitored area is too long for RDS-L gauges. Optical systems are not recommended where there is heavy fog or rain. Also, it should be noted that microprisms must be cleaned monthly to remove dust created by train braking systems

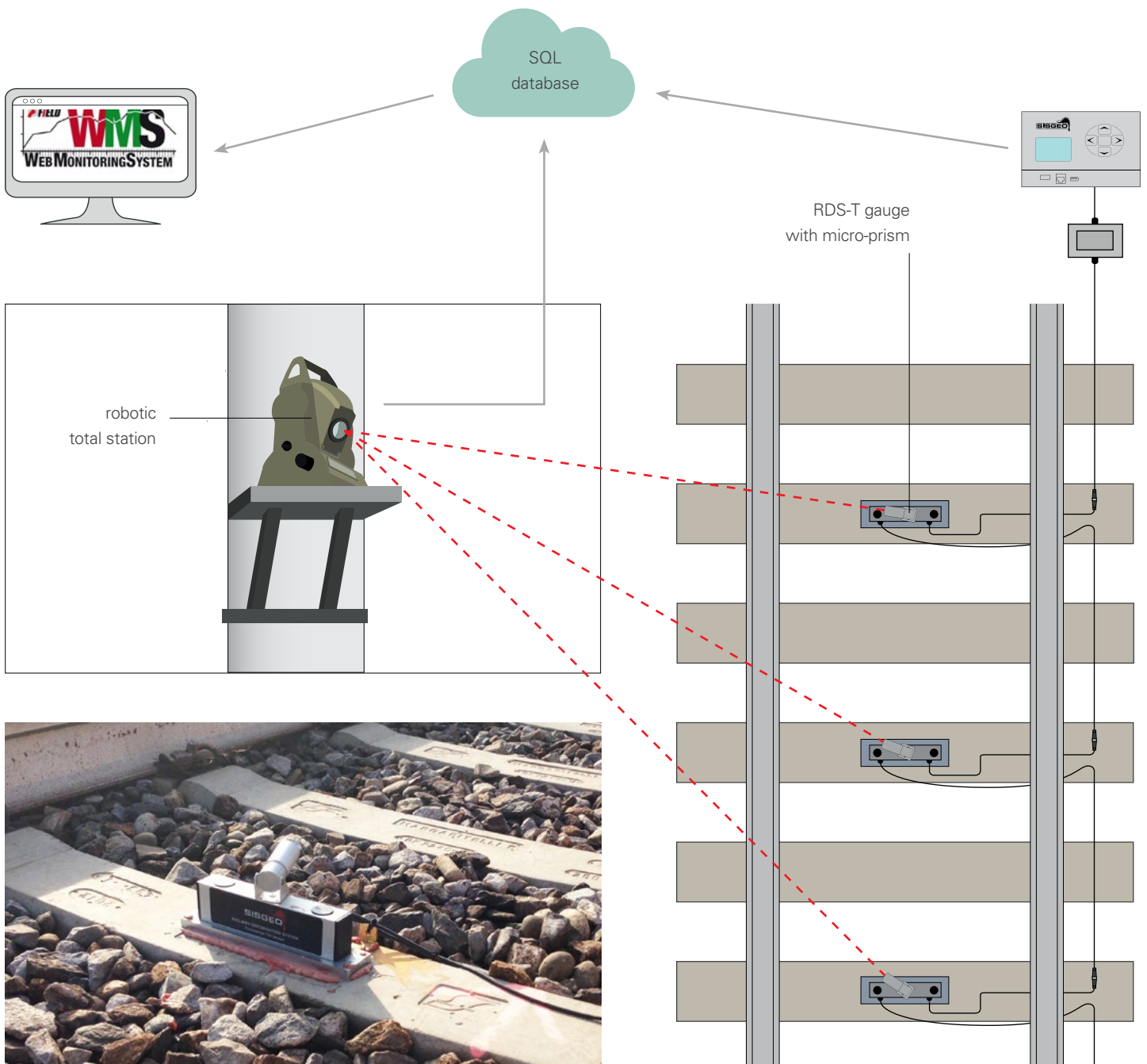



The WMS is a software platform designed and developed by Field Srl to validate, process, convert, compensate, manage, and automatically display data and graphs from geotechnical, structural, dynamic, meteorological and environmental monitoring systems.

OMNIAlog dataloggers and robotic total stations, equipped with any communication interface, send data to a remote server. The server then validates the data, removing spikes and anomalous readings, and processes the readings, converting them to engineering units, and finally adding them to its SQL database. The readings are then made available in the form of charts or tables through the "Galemys" application. The entire process is automated so that current data is available 24 hours a day, 7 days a week.

The charts are completely dynamic and can be configured by the user (colour, width, and visual characteristics of curves), the .xlsx files can be downloaded, and the status of instruments can be viewed through interactive tables or maps.

If a reading value exceeds a preset alarm thresholds, the WMS can send an alarm notification via SMS or e-mail to the mobile phones of registered users.

WMS can be configured to show any RDS information needed by the customer. For further information, visit the dedicated web page on the Field Srl web site www.fieldsrl.it/wms.

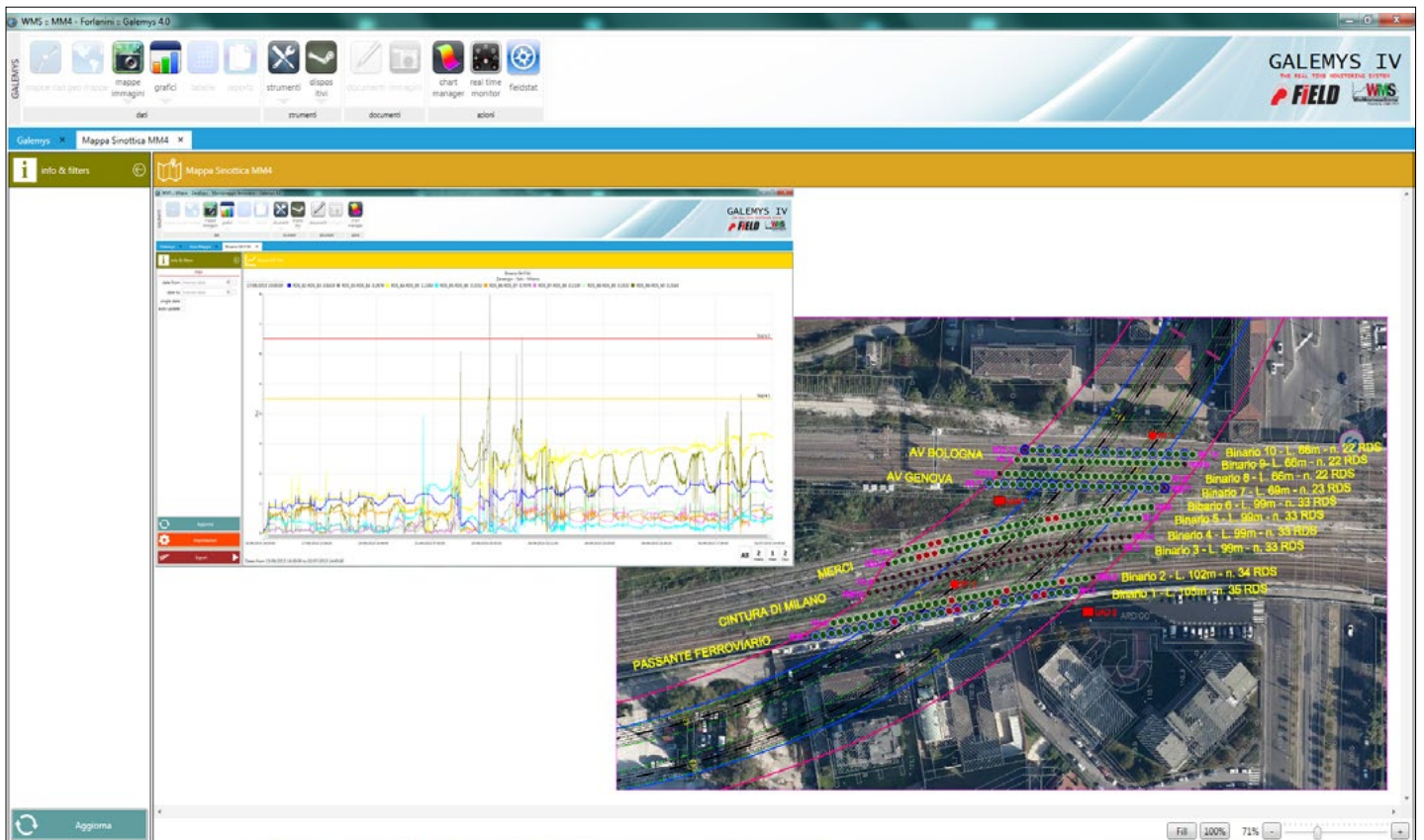

This WMS screen shot shows the position of the RDS gauges on job site with nine tracks where an underpass is being constructed. The plot represents the railway twisting. Alert and alarm thresholds are represented by straight yellow and red lines.

ACCESSORIES AND SPARE PARTS

RDS-L TERMINAL ANCHOR PLATE OS7RDS00LEO

Anchor plate used to terminate the RDS-L chain. It accommodates 150 mm of length adjustment, just as other anchor plates.

DIGITAL SIGNAL CABLE OWE606IPD2H

Used to connect the junction box of the RDS terminal kit to the datalogger. Cable has three twisted pairs (4x0.22 mm², 2x2.0 mm²).

RESISTANCE ENDING DEVICE OETERMRESIO

Termination resistance with connector, needed to close every digital RDS chain. The value of resistor depends on the layout of each system. For more detail see the [FAQ#076](#).

RDS-L SPARE ANCHOR PLATE OS7RDS00LSP

Used when an RDS-L must be moved to a new location, and its anchor plate cannot be moved with it.

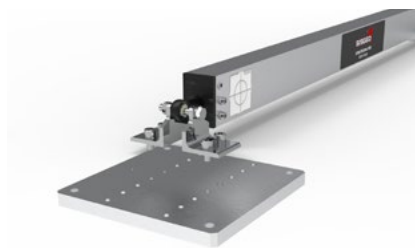
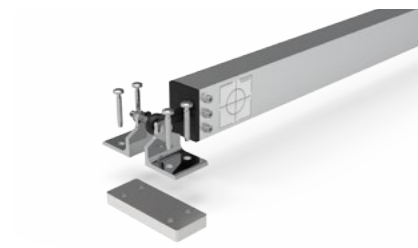

PLATE FOR WOODEN TIES OS7RDS00LWP

Steel anchor plate for mounting RDS-L



RDS TERMINAL KIT OS7RDSTER5M

Includes 5 m digital cable with waterproof connector to connect the closest RDS gauge and junction box.

RDS-T SPARE ANCHOR PLATE OS7RDS00TSP

Used when an RDS-T must be moved to a new location, and its anchor plate cannot be moved with it.

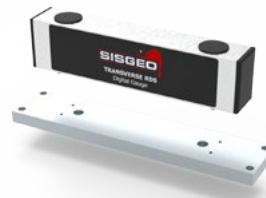

READABLE BY

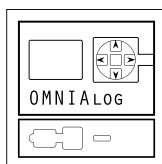
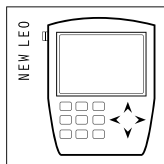

Refer to separate datasheets for further information.

All the information in this document is the property of Sisgeo S.r.l. and should not be used without permission from Sisgeo S.r.l. We reserve the right to change our products without prior notice. The datasheet is issued in English and other languages. In order to avoid discrepancies and disagreement on the interpretation of the meanings, Sisgeo Srl declares that English Language prevails.

SISGEO S.R.L.

VIA F. SERPERO 4/F1
20060 MASATE (MI) ITALY
PHONE +39 02 95764130
FAX +39 02 95762011
INFO@SISGEO.COM

TECHNICAL ASSISTANCE

SISGEO offers customers e-mail and phone assistance to ensure proper use of instruments and readout and to maximize performance of the system.

For more information, please refer to the FAQ pages on our website or email us: assistance@sisgeo.com