

# STARLOG

## Automatic Evaporation System

**Model 6529**



### **Copyright Notice**

Copyright © Unidata Australia 2001. All rights reserved. No part of this publication may be reproduced, transmitted, transcribed, stored in a retrieval system, or translated into any language or computer language, in any form or by any means, electronic, mechanical, magnetic, optical, chemical, manual or otherwise, without prior written permission of Unidata Australia, 40 Ladner St. O'Connor Western Australia 6163.

Printed in Australia

IBM® is a registered trademark of International Business Machines Corp.

## Contents

<b>1</b>	<b>INTRODUCTION</b>	<b>1</b>
1.1	Major Components Of Model 6529-1	2
1.2	Superseded Models	3
1.3	Automating Existing Evaporation Pans	3
1.4	Logging Evaporation	3
1.5	Example of Logged Data	4
<b>2</b>	<b>SPECIFICATIONS AND DETAILS</b>	<b>5</b>
2.1	Manual Recording System	5
2.2	Automatic Evaporation Recording	7
2.3	6529E Automatic Evaporation Recording And Level Control	8
<b>3</b>	<b>EVAPORATION MONITORING TECHNIQUES</b>	<b>11</b>
3.1	Using Evaporation Pan Data	12
3.2	Some Sources Of Errors In Evaporation Pans	12
3.2.1	Systemic Errors	12
3.2.2	Operating Errors	13
<b>4</b>	<b>SITE REQUIREMENTS AND LAYOUT</b>	<b>15</b>
4.1	Site Requirements For All US Class A Evaporation Pans	15
4.1.1	Water Supply	16
4.1.2	High Pressure Supply	16
4.1.3	Low Pressure Supply	17
4.1.4	Underground Supply	18
<b>5</b>	<b>INSTALLING THE EQUIPMENT</b>	<b>19</b>
5.1	Installing The Model 6529C Evaporation Pan	19
5.2	Installing The Model 6529A Enclosure	19
5.3	Installing The Stillwell Assembly	20
5.3.1	Connect The Stillwell To The Pan	21
5.3.2	Fill The Pan And Set The Water Level Instrument	22
5.3.3	Prepare The Float System And Stillwell Assembly	22
5.3.4	Install The Water Level Instrument	23
5.3.5	Set And Test The System	24
5.4	The Level Control System	25
5.4.1	Overview	25
5.4.2	Level Control Module	26

5.4.3	Fill System	26
5.4.4	Drain System	27
5.4.5	Power Supply	27
5.4.6	Installing The Level Control System	28
5.4.7	Install The Battery And Solar Panel	29
5.4.8	Install The Fill Solenoid	30
5.4.9	Install The Drain Pump	30
<b>6</b>	<b>OPERATING THE SITE</b>	<b>31</b>
6.1	Software Requirements	31
6.1.1	Overview Of The 6529E Scheme	31
6.2	Preparing To Log Data	31
6.2.1	To Adjust The Scheme Details To Suit Your Project	32
6.3	To Start Logging Data	36
6.4	To Check Data While Logging Is In Progress	37
6.5	Data Recovery And Review	38
6.5.1	Interpreting Evaporation Data	39
<b>7</b>	<b>SITE VISITS AND MAINTENANCE</b>	<b>41</b>
7.1	Site Visits	41
7.1.1	Preparing for the Site Inspection	41
7.1.2	Carrying Out The Site Inspection	42
7.1.3	Initial Inspection	42
7.1.4	Reviewing The Data	43
7.1.5	Recovering The Data	43
7.1.6	Carry Out Tests And Maintenance	44
7.1.7	Resetting the Logger	44
7.1.8	Final Site Check	44
7.2	Data Processing And Management	45
7.3	Site Maintenance	46
7.3.1	Overview	46
7.3.2	Site Surrounds	46
7.3.3	Evaporation Pan and Level Monitoring System	46
7.3.4	Input Water Supply	47
7.3.5	Solenoid/Pump	47

## 1 INTRODUCTION

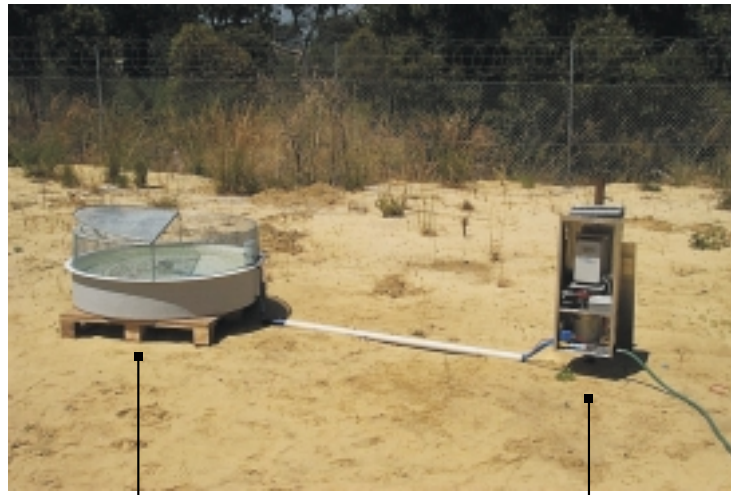

Evaporation pan  
with bird guard

Water level monitoring  
and control system

This supplement describes the installation and operation of UNIDATA's Model 6529 Automatic Evaporation System. This is an advanced system that automatically operates an evaporation pan and records the evaporation and rainfall data. The instrument is normally supplied as a complete package with a US Class A evaporation pan and all installation fittings. It can be connected to any other type of pan.

The system is designed to operate for long periods without maintenance. The water level transducer and data logger operate for one year from internal batteries. The water level control system is solar powered. The water supply to refill the evaporation pan is provided by the user from a tank or a reticulated water supply pipe. Rainfall removed from the pan can be recycled if required.

A water temperature sensor and a range of weather sensors can be added to identify the relationship between pan evaporation and site conditions. This is required for evaporation and evapo-transpiration studies and modelling. An optional telemetry system can be connected to the datalogger. Landline, cellular, satellite and radio communication links can be used to monitor data and operate the site.

### 1.1 Major Components Of Model 6529-1

#### ■ Water Level Monitoring And Control System

Model 6529A Water level monitoring system for STARLOGGER.

Model 6529A/C Water level monitoring system with integrated Micrologger to record data.

Model 6529E Automatic water level controller.

#### ■ Evaporation Pan And Bird Guard

Model 6529C Evaporation pan 1200mm diameter, fibreglass.

Model 6529D Bird and leaf guard for Model 6526C.

#### ■ Weather Monitoring Instruments

Additional instruments that can be added to the Model 6529A/C are:

Model 6529B Thermistor and float assembly to measure pan water temperature.

Model 6506A Tipping bucket rain gauge.

If the Model 6529A and STARLOGGER are used, any additional UNIDATA instruments can be added such as:

Model 6504FS Wind speed and direction.

Model 6501DU Air temperature, relative humidity, and solar radiation.

Model 7201A Net Radiation.

Model 6513A Soil Moisture.

Model 6522B Barometric Pressure.

## 1.2 Superseded Models

This system supersedes the previous UNIDATA Model 6529-1 instrument.

## 1.3 Automating Existing Evaporation Pans

The evaporation instrument system and optional weather instruments can be added to any evaporation pan installation. Contact your nearest UNIDATA support office for advice on upgrades.

## 1.4 Logging Evaporation

A special instrument and scheme have been created within the UNIDATA software to monitor the recorded water level, extract the evaporation and rainfall data, and reset the pan water level. These have been included with STARLOG v3.09E (or later) and are supplied on disk with initial releases of the instrument. Alternatively, you can obtain this update from the technical support section on the UNIDATA web site - [www.unidata.com.au](http://www.unidata.com.au). Refer to *Software Requirements* on page 31 for details on how to install the update.

This scheme offers you the options to log the raw water level, total evaporation and total rainfall. You can log either one daily total or measurements throughout each day. The evaporation data accumulates all 0.2mm water level falls, and the rainfall data all 0.2mm rises. The effects of any pan water level resets and minor water level pulsations are not recorded.

## 1.5 Example of Logged Data

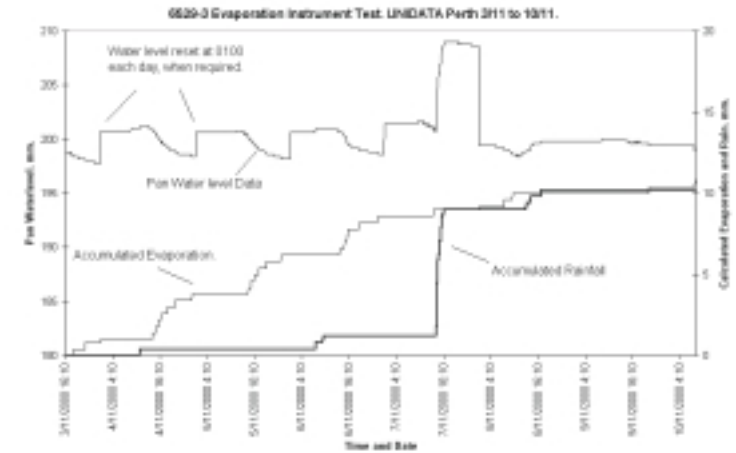

*This page intentionally left blank.*

## 2 SPECIFICATIONS AND DETAILS

### Evaporation System

Pan Type:	US Class A compatible.
Range:	30mm to 250mm. Pan empty to full.
Resolution:	0.2mm of evaporation or rainfall.
Accuracy:	+/- 0.4mm
Level Reset:	Programmable. Default reset to 200mm (+/- 1mm) at a preset time each day. Also resets 10mm below the overflow level.
Reset rate:	Pumps 50mm out in 3 minutes. Fills 3mm per minute with 10kpa (1m) head. Rate of refill increases as head increases.

### 2.1 Manual Recording System

#### Model 6529C Evaporation Pan

Dimensions:	Internal diameter 1208mm, outside diameter 1290mm. Depth 250mm.
Operating depth:	200mm.
Volume at operating depth:	229 litres.
Material:	Fibreglass. Internal surface gloss white. Pre-drilled with two 20mm diameter holes for hose fittings.
Intake:	Bulkhead fitting for 12.5mm ID hose. Connects level gauge to stillwell.
Refill:	Bulkhead fitting for 12.5mm ID hose. Connects level control system to pan.
Pan weight:	12kg.
Mounting:	Timber frame 1300 x 1300. Treated plantation softwood.
Mounting weight:	20kg.

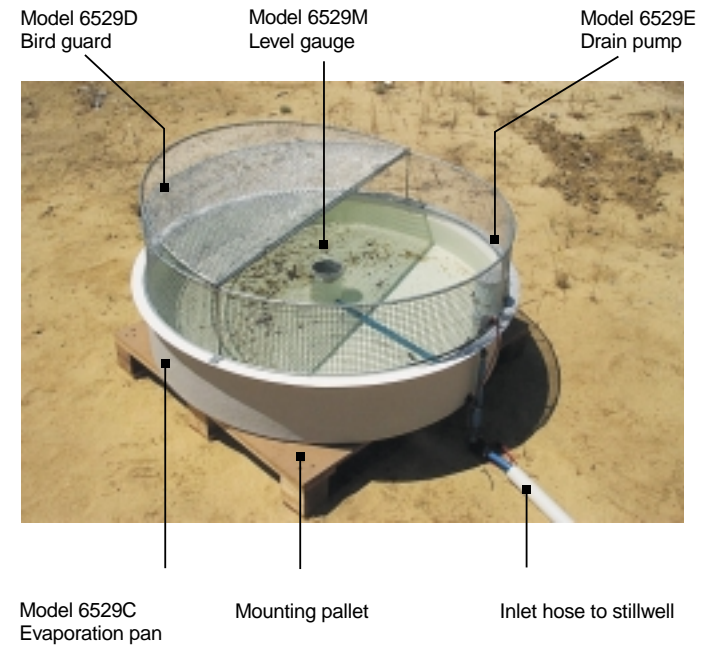

#### Model 6529D Evaporation Pan Bird Guard

Dimensions:	Outside diameter 1200mm. Height 250mm.
Material:	Frame - 8mm steel rod. Mesh - 12mm square steel mesh.
Finish:	Hot dip galvanised.
Weight:	12kg.

#### Model 6529M Point (Level) Gauge

Material:	PVC or Stainless Steel cylinder with point gauge at 200mm.
Connectors:	Hose and fittings to connect to intake from stillwell.

#### Volumetric Flask

Material:	Clear PVC graduated container.
Capacity:	2000ml

## 2.2 Automatic Evaporation Recording

### Model 6706A Aluminium Enclosure

- Dimensions: 320mm x 300mm x 750mm (Width x Depth x Height).  
Vertically sliding front door. With hole for (purchaser supplied) padlock.
- Material: 2mm aluminium sheet. Powder coat finish.
- Mounting: 1300mm long galvanised steel pipe, 40mm diameter with cap. Two U-bolt assemblies to suit pipe.

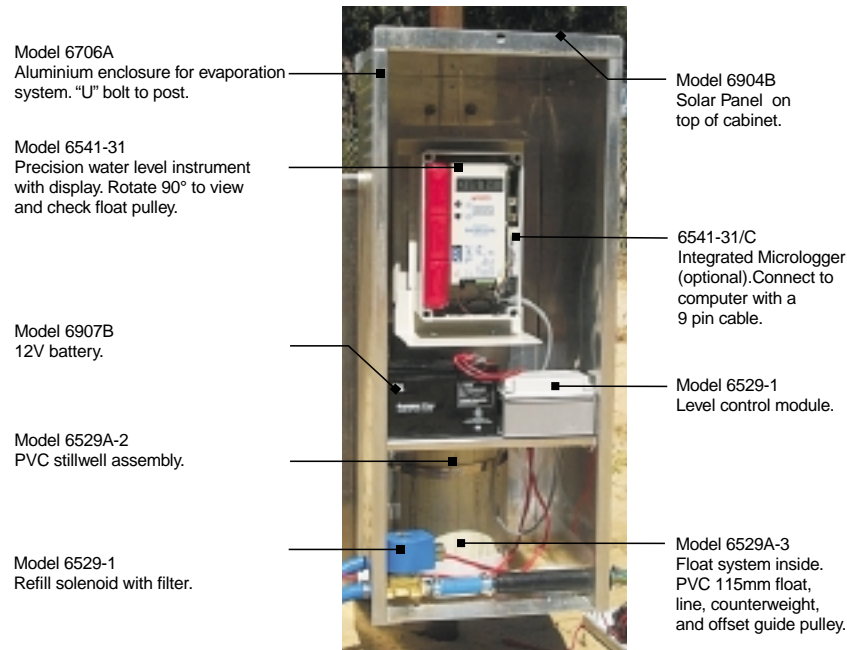

### Model 6529G Stillwell Assembly

- Dimensions: 370mm high, 150mm diameter, with sealed bottom.
- Material: PVC pipe.
- Stillwell Cap: PVC Cap predrilled for float system and 6541. Cap rotates to allow rear of 6541 to be visible.
- Connector: Bottom fitting for 12.6mm hose to evaporation pan.

- Hose: 12.6mm heavy-duty flexible hose, 1.8 metres long.  
Two stainless steel hose clamps supplied.

- Hose guide: PVC pipe, 40mm diameter, and 1300mm long.

### Model 6541 Water Level Instrument

See the User Guide for the Model 6541 instrument for specifications.

- Float system: Float pulley 100mm circumference. Offset pulley fitted.  
Float 115mm PVC. Counterweight -160 grams.  
Floatline 0.4mm diameter stainless steel. 690 mm long.

## 2.3 6529E Automatic Evaporation Recording And Level Control

### 6912BR/12 Level Controller

Circuit card with relays to operate fill solenoid and drain pump, and a solar charge regulator for battery.

- Enclosure: UV stabilised polycarbonate, IP67.
- Size: 125mm x 75mm x 75mm (L x W x D).
- Terminals: Pluggable terminal strip with terminals for fill solenoid, drain pump, solar panel, battery and test.
- Cables: 1m cable to data logger terminal block of 6541-31/C.  
0.3m battery leads.

### Fill Solenoid

- Type: Solenoid valve with 10mm bore and nitrite seals. Cable length 0.5m.
- Power: 12 volts @ 1.2 amps.

### High Pressure Application

- High Pressure Solenoid: Goyen 10BWJ-CNBNT-61D7.  
Maximum pressure 1000kPa.  
Minimum recommended pressure 10kpa.
- Spare parts kit: GOYEN KM1664.

### Low Pressure Application

- Low pressure solenoid: GOYEN 10BL2-CNBNT-61D7 direct acting solenoid.
- Maximum pressure: 70kPa.
- Minimum pressure: 0kPa.
- Recommended minimum: 10kPa.
- Spare parts kits: GOYEN KM1423.
- Pump: Optional pump (same as drain pump) if gravity feed not possible.
- Inlet Hose: 12.5mm heavy-duty flexible hose, 2 metres long to connect to tank.
- Two stainless steel hose clamps supplied.
- Inlet filter installed upstream of solenoid.

### Drain Pump

- Type: Marine bilge pump. Located in pan. Cable length 2 metres.
- Power: 12 volts @ 1.2 amps.
- Capacity: Maximum 20 litres/minute.
- Housing: PVC enclosure attached to inside of pan.
- Drain Hose: 12.5mm hose can be connected. Not normally supplied.

### Power Supply

- Power supply: Maximum 0.3 ampere hour/day with daily level reset.
- Battery: Model 6907B 12 volt, 7 ampere-hour sealed lead acid battery.
- Charger: Model 6904B 12 volt, 2 watt solar panel on enclosure roof. Regulated by circuit in level control system.

*This page intentionally left blank.*

### 3 EVAPORATION MONITORING TECHNIQUES

Evapo-transpiration is the endless cycle of moisture returning to the atmosphere to condense and fall again as rainfall. Evaporation occurs from soil and water surfaces, and transpiration from vegetation. The energy that drives the process comes from solar and terrestrial radiation. The rate is influenced by a complex interaction of many factors including the topography, geology and botany of the area, the moisture content of the soil, the moisture availability to vegetation and the local weather. As many of these factors vary throughout each day, and with the seasons, the rates are continually changing at any given site. Evapo-transpiration is too complex to measure directly.

An evaporation pan is a practical way to measure the loss of water from a small water surface. This is not a *real* measurement of any part of the natural evapo-transpiration process. Evaporation rates from lakes, soil surfaces and vegetation will be different from a pan.

Historically, many different shapes of evaporation pan and methods of installation have been used. Different designs produce unique results. If data from one pan is to be compared with another, both pans must be the same. To allow the standardisation of data and research across different sites and countries, the World Meteorological Organisation (WMO) recommends the use of the United States Class A pan as a general-purpose network instrument. This type of pan is widely used in many countries.

The UNIDATA evaporation pan conforms to the dimensions of the US Class A pan.

Networks of US Class A evaporation pans are operated by many organisations in many countries. The records can extend back for 50 years or more. This data is typically a daily reading of the total evaporation. This is measured manually by an observer visiting the site at the same time each day and reading the total loss (or gain) in the pan water level, and adjusting for the rainfall. The pan water level is then reset to the operating level.

The UNIDATA evaporation system with level control is designed to simulate this daily operation. This will produce data comparable with a manual pan.

#### 3.1 Using Evaporation Pan Data

The daily total evaporation can vary from 0 on a cool and misty day, to more than 25mm on a hot, dry and windy day. Care must be taken in extrapolating the pan evaporation data to other sites or to estimating losses from natural water bodies. For instance studies indicate that lake evaporation varies between 75% and 100% of pan evaporation, depending on location and climatic conditions.

If there is a manual evaporation site in your region with a long history of evaporation data, it is often possible to develop a relationship between the monthly and annual evaporation at the two sites. With a reliable correlation based on several years of data, you can theoretically extend the period of data from your site back in time, using the historic data.

The pan data from your site can be used to estimate some aspects of nearby evapo-transpiration only if the relationships are known or can be estimated. These relationships can only be measured by controlled experiments. Much research has been completed using US Class A pan data to estimate lake evaporation, soil evaporation and local evapo-transpiration. Several different formulae and models have been developed to compute the potential evaporation, based on solar radiation and weather data. Experienced hydrologists can frequently determine reasonable relationships between pan evaporation and lake and soil evaporation from nearby areas of interest. Pan evaporation is then the simplest way to carry out the basic long-term monitoring. Some additional soil moisture and weather data may be required for evapo-transpiration monitoring.

#### 3.2 Some Sources Of Errors In Evaporation Pans

##### 3.2.1 Systemic Errors

**Bird guards** are required at many sites, to stop animals drinking the water and to keep out wind blown debris. These guards reduce the recorded evaporation by about 10%-12% because the mesh and frame partially shades the water surface, reduces the airflow, and intercepts some rainfall.

UNIDATA recommends that measured evaporation data should be increased by 10% if a bird guard is used.

**Water quality** has a minor effect. Seawater evaporates 2% to 3% less than fresh water. Turbidity has no apparent effect.



UNIDATA recommends no adjustments are normally required.

**Pan corrosion** changes the interior surface colour and texture. The difference between a black painted and unpainted galvanised iron pan is approximately 10%.

UNIDATA pans are constructed of white fibreglass to minimise discolouring or deterioration with poor water quality.

### 3.2.2 Operating Errors

Evaporation pans are normally manually operated and require daily reading and resetting. This is difficult or impossible at remote sites and data quality is compromised.

**Water level too high** will result in rainfall splashing or blowing from the tank when it is near full, and overflowing when it is full.

**Water level below the reference mark** increases the shading from the sides of the tank and reduces evaporation by up to 2.5%/10mm below the reference level, in temperate regions.

**Water level very low** records increased evaporation as the temperature of water in the pan increases.

UNIDATA recommends these errors be avoided by automatically controlling the water level.

*This page intentionally left blank.*

## 4 SITE REQUIREMENTS AND LAYOUT

### 4.1 Site Requirements For All US Class A Evaporation Pans

Site requirements are frequently a compromise. The following features are desirable when selecting a site. They are listed in order of importance.

- If the site is near a water body or a spray irrigation or reticulation system, it should be at least fifty metres away and on the prevailing upwind side.
- The site should be secure from unauthorised interference and easy to access and service.
- Select a level, open site, free from obstructions such as trees, bushes and buildings that will shade or shelter the site from wind. The evaporation pan should be in the full sun.
- Any obstruction should be at a distance from the pan of at least 4 times the height above the pan rim.
- Select an area six metres square. If necessary fence the area using an open fencing system with minimum wind resistance.
- Maintain the ground cover within the fenced compound in a similar condition to the natural surroundings. Keep vegetation trimmed to below the pan rim height.

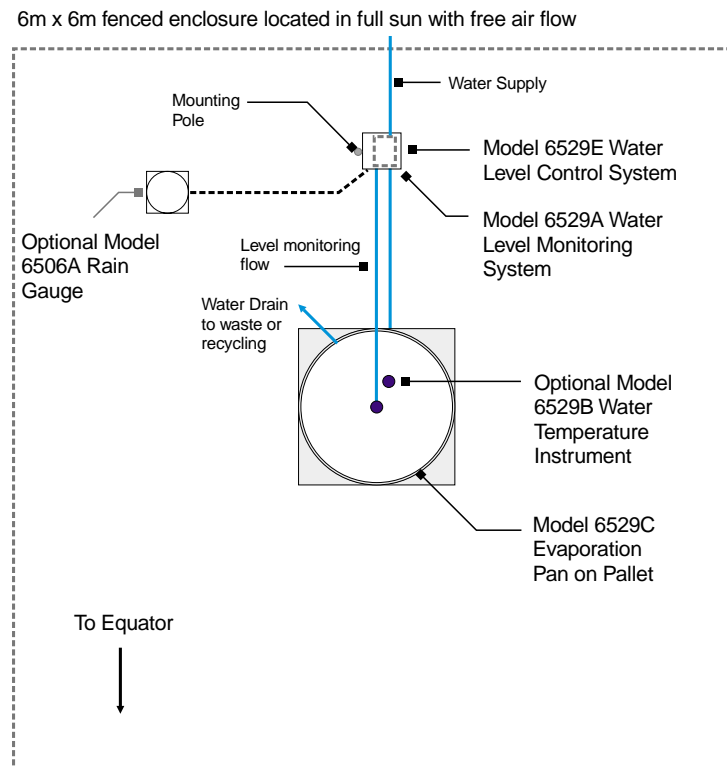

#### 4.1.1 Water Supply

The evaporation pan is refilled each day by the level control system. The automated refill is controlled by a solenoid switched on by the datalogger in response to the level registered on the water level transducer.

The instrument must be permanently connected to a reliable supply of potable water. Some typical examples are shown in the following sections. Solenoids and pumps can be supplied to suit all applications.

#### 4.1.2 High Pressure Supply

The simplest method is to connect to a reticulated water supply of potable water. A pipeline is required to the site, terminating in a tap or shut-off valve. A short length of m12.5 hose can be used to connect to the solenoid filter.

A high pressure solenoid with a range of 10-100kPa is available as an option.

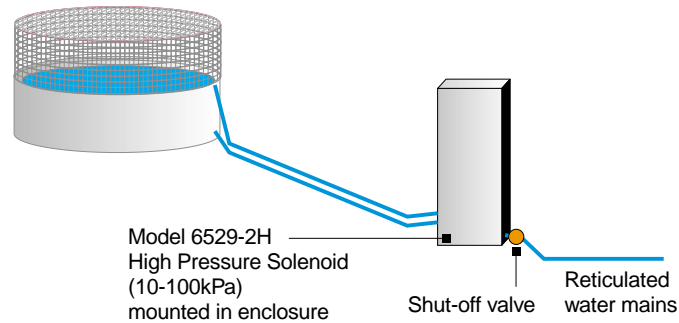

The maximum desirable pressure is 200kPa. In some circumstances a pressure reducing valve may be required to prevent high pressure leaks.

#### 4.1.3 Low Pressure Supply

The water supply can be from a mains system or a special storage tank. The supply pressure should be between 10kpa (1 metre head) and about 50kpa (5 metre head). The supply is normally a tank that is refilled at regular intervals. A 1000 litre tank will replace about 750mm of evaporation. The tank capacity that you need depends on the expected evaporation at your site, and when you can conveniently refill the tank.

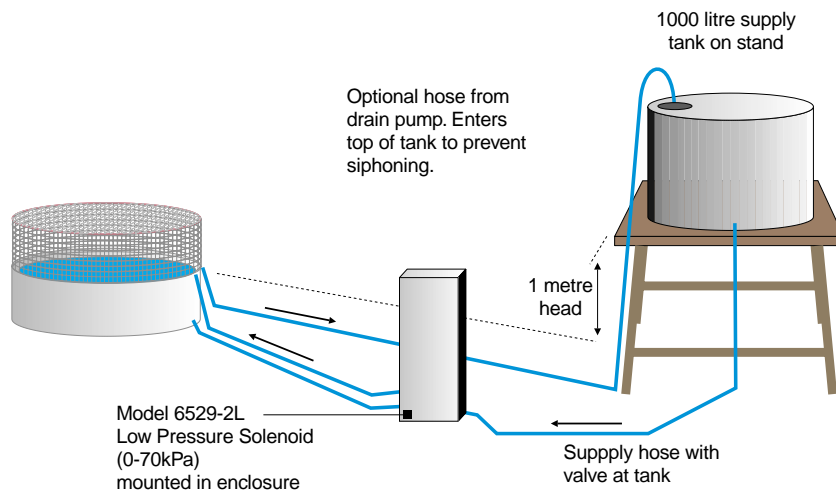

#### 4.1.4 Underground Supply

Where the water supply is scarce or inconvenient, it is possible to install a tank large enough to be self-sustaining at most sites. Any excess rainfall captured in the pan can be recycled back into the storage tank. A roof over the tank can be used to capture additional rainfall. If required, the tank can be buried and a small pump used to refill the pan.

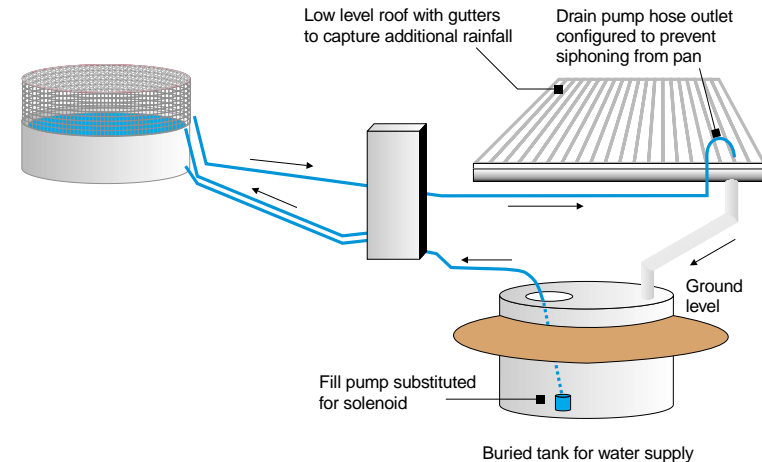

The expected annual evaporation and rainfall, and the monthly distribution can be estimated from published data from your national weather office. This can be used to design the capacity of your supply tank.

## 5 INSTALLING THE EQUIPMENT

### 5.1 Installing The Model 6529C Evaporation Pan

The evaporation pan should be located in the centre of the compound. The pan is installed on an open timber palette constructed from timber treated with suitable preservatives. The pallet should be firmly bedded into the natural surface with the top 50mm to 75mm above ground level. Do not install the pan on a concrete, bituminous or gravel pad. It is essential that air circulates freely beneath the pan, and that any leaks can be seen.

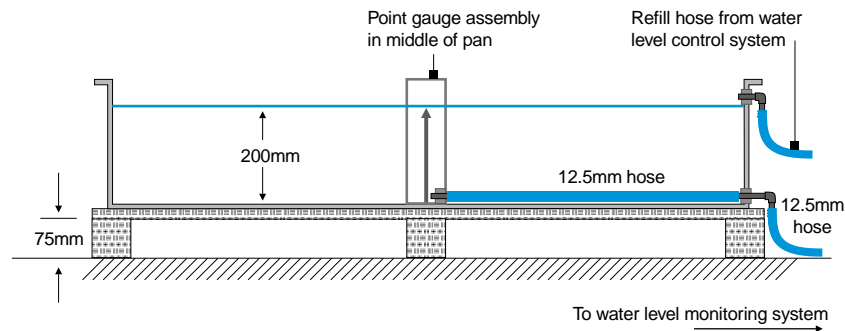

Rest the pan centrally on the pallet. Rotate it to orient the hole in the pan toward the location of the stillwell assembly. Assemble the hose fittings through the hole at the bottom of the sidewall of the pan. Seal the joints with a smear of silicon. The assembled fitting has a hose barb on each side of the tank wall.

Install the Model 6529-C1 level gauge. Attach the 550mm hose to the gauge and to the inside barb in the pan wall. No hose clamps are used because (very) small leaks will not affect operation. Position the level gauge in the middle of the evaporation pan.

### 5.2 Installing The Model 6529A Enclosure

The stillwell enclosure is located 1.5 metres from the pan, on the side away from the equator, where it will not shadow the pan. Near the equator, install it on the western side of the pan.

Concrete the 40mm galvanised pipe firmly into the ground. Attach the enclosure to the pole using the U-bolts supplied. Face the side with the hole for the stillwell hose toward the pan. Move the enclosure up/down the pole until the bottom is 20mm below the bottom of the evaporation pan.

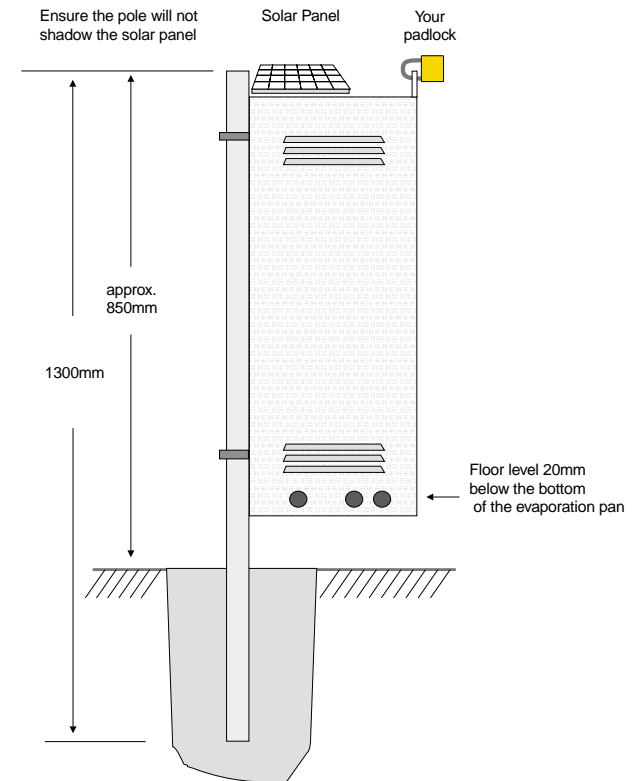

### 5.3 Installing The Stillwell Assembly

Do the following:

1. Leave the 6541 instrument off the stillwell during initial installation.
2. Thread the 1.5 metre hose through the hole in the side facing the pan.
3. Connect the hose to the barb fitting in the base of the stillwell. Fix it with a hose clamp.

- Put the stillwell assembly into the enclosure. It stands on the enclosure floor at the back. Clamp the stillwell to the bracket with the stainless steel hose clamp supplied.

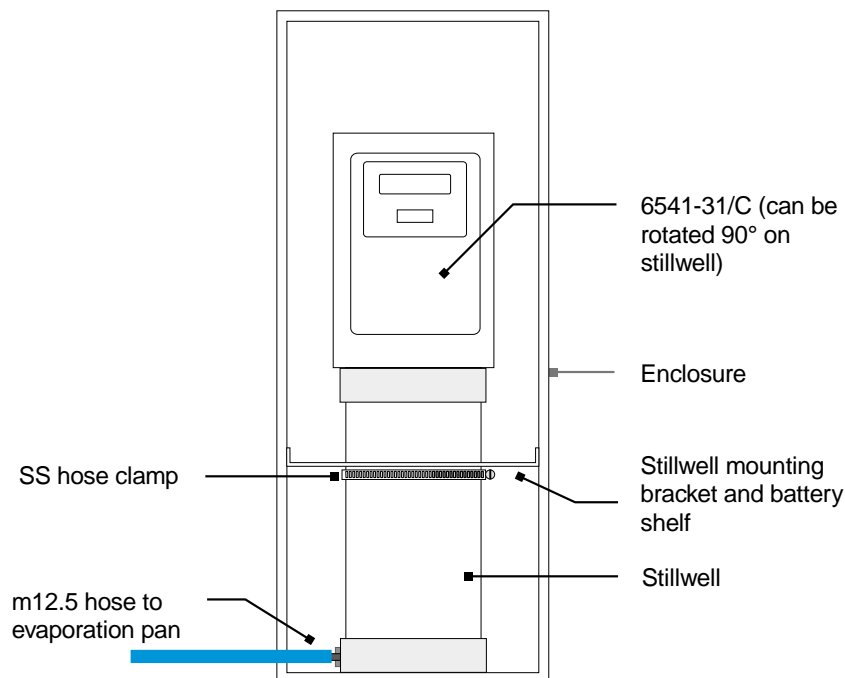

### 5.3.1 Connect The Stillwell To The Pan

A flexible hose is used to link the stillwell to the evaporation pan. It is normally buried to protect it from accidental damage. This hose ensures that the water level in the pan and stillwell are the same at all times.

An air lock could form in the hose if there are any high points. This can restrict or block water transfer and prevent the system from operating correctly.

To keep the hose straight, sleeve it with a piece of 40mm PVC pipe before it is buried. This also serves as a duct for the fill hose and the drain pump cable. Lay the sleeved hose into a shallow trench between the stillwell and pan. Cut the hose to length and connect it to the pan, using a hose clamp.

### 5.3.2 Fill The Pan And Set The Water Level Instrument

Fill the pan with water to near the reference point in the pan level gauge. Check the hose connections and the pan for leaks and fix any problems.

Confirm that the water level in the stillwell is the same as in the evaporation pan, and that they move together. An airlock in the hose system can prevent this happening. To check, take some water from the pan and almost fill the stillwell. Check that it drains back to the previous level. If it doesn't, clear the air lock.

To clear an airlock, remove the hose from the level gauge and blow through it until it bubbles into the stillwell. Replace the hose and confirm the water transfer is OK.

### 5.3.3 Prepare The Float System And Stillwell Assembly

Do the following:

- Bolt the Model 6541-31/C instrument to the stillwell cap, with the two bolts provided. The instrument must be fitted with a 100mm-circumference float pulley and an offset pulley.
- Prepare the float system. This is normally supplied as an assembly, ready for installation. However, if you need to prepare it yourself, follow these steps:
  - Loop one end of the floatline through the eye of the float. Use two crimps to fix the loop.
  - Place the float in the bottom of the stillwell. Thread the floatline up through the centre hole in the stillwell cap. Place the cap and instrument in position on the stillwell.

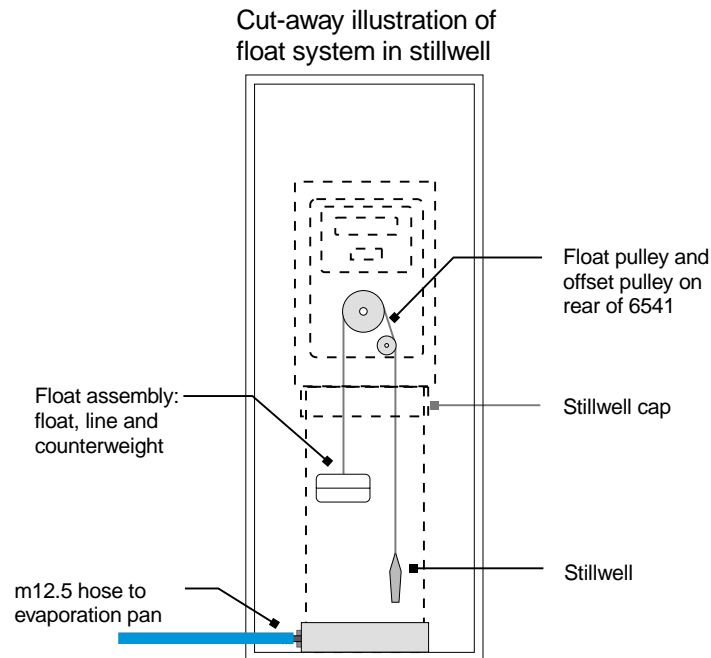

- Thread the floatline over the instrument pulley, then the offset pulley, and loop it through the eye of the counterweight. Adjust the length such that the counterweight eye is just above the side hole in the stillwell cap. Use two crimps to fix the loop.

### 5.3.4 Install The Water Level Instrument

The 6541 sits on top of the stillwell. The display normally faces the front. The instrument can be rotated ninety degrees if you need to see the floatline at the back.

To install the 6541 instrument:

1. Remove the rear sliding plate. This is not required at these sites, and there is not room to lift it off inside the enclosure. Keep the rear plate for later use.
2. Place the float onto the water surface in the stillwell.
3. Rest the instrument on the side of the stillwell. Thread the counterweight up through the centre hole in the cap, over the pulleys and down through the outer hole.

4. Place the instrument into its final position on the stillwell.
5. Rotate it to a side-on position. With the floatline installed on both the float pulley and offset pulley, check that the float and counterweight can rise freely from the bottom to the top of the stillwell, without clashing, or touching the sides.
6. Rotate the instrument back to its operating position.

See the 6541 User Manual (publication number 6209) for detailed information on the operation of the 6541 instrument.

Remove the front cover from the 6541. Confirm that the following transducer switch settings have been selected. These are required for the correct operation of this instrument.

Switch Number	Switch Position	Function
1	Off	Direction of rotation to increase display as level rises.
2	On	Direction of rotation to increase display as level rises.
3	Off	Reserved.
4	Off	Reserved.
5	On	Switches display to a resolution of 0.2mm.
6	Off	Switches display to a resolution of 0.2mm.
7	Off	Switch on only to reset to zero.
8	On	Internal battery On.

### 5.3.5 Set And Test The System

Adjust the level of the water in the evaporation pan to the exact level of the point gauge. Turn on the 6541 and set the display to read 200.0 mm using the arrow keys.

To test the system, use the measuring flask to add or remove water from the evaporation pan. The display should change by 0.2mm for each 230 ml of water added or removed from the tank. The stillwell level will slowly adjust to the new pan level. Confirm that the display moves in the same direction as the pan water level changes.

## 5.4 The Level Control System

### 5.4.1 Overview

The purpose of the level control system is to reset the evaporation pan water level back to its reference level at a regular time each day. You can set the reset time to suit your project. This replicates the operation of a manual evaporation pan, and produces similar data. After operating for 24 hours the water lost to evaporation is replaced from a tank or other water supply. If the pan is overfull from rainfall the excess is pumped from the pan. This can be recycled back to the supply tank if site water is scarce.

The pan water level recorded by the data logger is used to control the reset. At the specified time the logger will decide if water is to be added or removed. It then switches on the appropriate device until the reference level is reached. If the pan is in danger of overflowing from heavy rainfall the pan will also be reset.

A level control module consisting of a switch card in a polycarbonate enclosure controls the reset. This switch card is operated by the site MICROLOGGER or by an associated STARLOGGER or PROLOGGER. This card has relays with the capacity to operate either solenoids or small pumps. Either device may be used depending on the site. Power is supplied by a solar powered battery system. A regulator on the switch card manages battery charging. All devices connect to the row of pluggable terminals located at the front of the enclosure.

### 5.4.2 Level Control Module

This self contained instrument is normally located near the battery and solenoid or pump. There are no internal settings or adjustments. A cable connects it to the site data logger terminals.

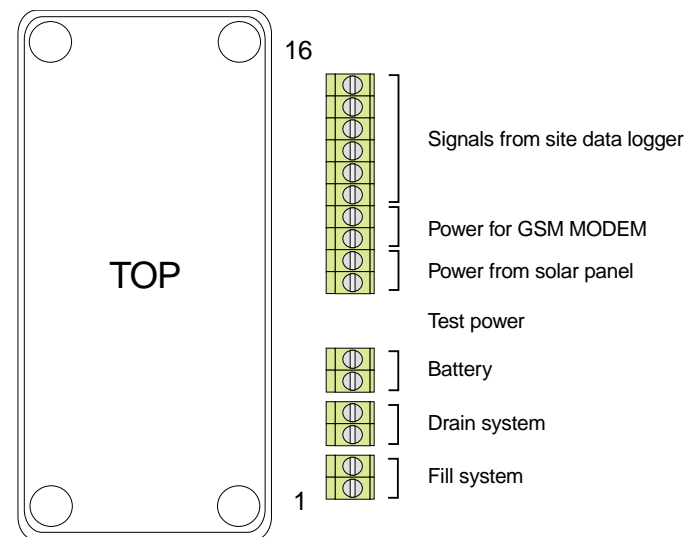

The other components of the system plug into the marked terminals.

A Test terminal socket is provided. This has continuous 12V power. Plug in your fill or drain device if you want to test run it.

Contact your local UNIDATA support centre for advice if you wish to fit the controller to an existing instrument, or use it for another purpose.

### 5.4.3 Fill System

A solenoid valve is normally used to turn on a water supply and add water to the evaporation pan. This is typically turned on by the data logger at 0900 each day, if the water level is low and turned off when the level is correct. The solenoid is located in the base of the instrument enclosure. The outlet of the solenoid is connected to the evaporation pan by a 12.5mm (½") hose. This hose enters the pan above water level to avoid any chance of water siphoning back out of the pan.

A filter is located upstream of the solenoid. This has a removable element to simplify cleaning. The filter connections suit a 12.5mm (½”) hose from the supply tank. A small pump may be operated if an underground water supply is used.

#### 5.4.4 Drain System

A small pump is used to remove surplus water (rainfall) from the pan. If the data logger detects the water level is higher than the reference at the reset time (0900hrs), the pump is turned on until the level is correct. The pump is also switched on to reset the pan level if rainfall increases the tank level to 240mm. The pump has the advantage of moving the water quickly and being able to recycle it to a tank.

The pump mounts in a housing designed to stand within the evaporation pan, and discharge water over the side through a 12.5mm (½”) hose fitting. A hose can be connected to this fitting to direct the pumped water to storage or away from the site.

The end of any drain hose should discharge into air at a higher level than the pan top to prevent water siphoning in or out of the tank.

The submersible bilge pump is installed inside a small housing made from PVC. Terminals beneath the lid connect the pump with the cable to the control system. The pump housing can be lifted from the well, separated in the middle and the pump lifted out for cleaning. The bottom of the pump can be removed to clean and service the impeller.

The pump must be inverted when installed for reliable self-priming; the inlet must be at about 190mm above the pan bottom. This prevents a malfunctioning pump from draining the evaporation pan.

#### 5.4.5 Power Supply

The system is powered by a 12-Volt, 7 Ampere-Hour sealed lead acid battery. This is recharged by a 12-Volt 2-Watt solar panel located on the top of the enclosure. A regulator on the relay card maintains the battery in a fully charged condition. This will power the level control system for an expected service life of at least three years.

The battery capacity is sufficient for up to two months of operation, without recharging. When the sun shines the solar charger can replace the typical daily power consumption within one hour.

#### 5.4.6 Installing The Level Control System

There is a row of 16 pluggable terminals on the level control module. A strip of 8 terminals permanently connects the data logger, GSM modem and solar panel. Strips of two terminals are used to connect the battery and the drain and fill devices. The Test socket is normally empty. You can plug in the Drain or Fill device at any time to test it or to manually adjust the pan water level.



Control Module Terminal	Connected Device	To	Remarks		
1	Fill System	+	Switched on to add water to evaporation pan.		
2		-			
3	Drain System	+	Switched on to remove water from evaporation pan.		
4		-			
5	Testing	+	Normally vacent . Plug in the fill or draw system to test.		
6		-			
7	Battery	+	Connectes to rechargeable selaed klead acid battery.		
8		-			
9	Solar Panel	+	Connects to solar panel.		
10		-			
11	GSM MODEM	+	Provides power for GSM MODEM (if required).		
12		-			
			6541-31C	STAR-LOGGER	PRO-LOGGER
13	Data Logger	OUT0	Terminal 3	FTS 42	44
14	Relay control signals	UPS (OUT1)	Terminal 1	FTS 47	45
15	External Power	+	Terminal 11	FTS 1	1
16		-	Terminal 13	FTS 2	2

#### 5.4.7 Install The Battery And Solar Panel

Stand the battery on the bracket holding the stillwell. Use the cable supplied to connect the battery to terminals 7(+) and 8(-).

Bring the solar panel wires through the gland in the cabinet roof. Mount the solar panel onto the top bracket with the two screws in the panel frame. Use tamper-proof screws if security is a concern. Connect the solar panel to terminals 9(+) and 10(-).

#### 5.4.8 Install The Fill Solenoid

Place the solenoid outlet through the front hole of the three at the bottom of the left-hand wall of the cabinet. Attach the hose to the pan, and seal it with a hose clamp. Connect the pan end of the hose to the fitting in the top hole of the pan, and fasten it with a hose clamp.

Push the filter and short joiner hose through the hole in the opposite side of the cabinet. Join the hose to the solenoid inlet with a hose clamp. Connect your water supply hose to the inlet of the filter. Fit a tap or shut-off valve at the water supply point.

Connect the solenoid lead and plug it into terminal 1(+) and 2 (-) of the terminal strip. You can test the solenoid operation by plugging in to the test position. The solenoid should click open when you plug it in and click shut when you unplug it.

#### 5.4.9 Install The Drain Pump

Stand the pump assembly in the pan near the inlet. Direct the outlet fitting through the mesh of the bird guard. You will have to cut out a small panel of mesh. Attach the pump assembly to the mesh of the bird guard using the stainless steel hose clamp provided. Run the cable alongside the inlet hose and into the cabinet through the cable gland provided.

Plug the pump cable into terminals 3(+) and 4(-) of the terminal strip. To test the pump, transfer the plug to the test position. The pump should run when you plug it in, and stop when you unplug it.

## 6 OPERATING THE SITE

This instrument is operated in the same way as any other UNIDATA Instrument. You use the same software to program and test the logger and unload and view data. See the Version 3 Software Manual for detailed information.

### 6.1 Software Requirements

You will need a laptop computer, a cable, and Starlog Version 3.09E (or later) software. You can obtain updates from the technical support section on [www.unidata.com.au](http://www.unidata.com.au). A special Evaporation Instrument and Scheme have been created to monitor the recorded water level, extract the evaporation and rainfall data, and reset the pan water level. This software is supplied on disk with initial releases of the instrument. Copy the files:

- 6529E\*. \* to the Starlog\Schemes folder.
- PDL6529E.SRC to the Starlog folder.
- PDLTRANS.MET to the Starlog\Eng folder.

#### 6.1.1 Overview Of The 6529E Scheme

This scheme offers you the options to log the raw water level, total evaporation and total rainfall. You can log either one daily total or details throughout each day. The evaporation data accumulates all 0.2mm water level falls, and the rainfall data all 0.2mm rises. The data is logged in increments of 0.4mm. The effects of any pan water level resets and minor water level pulsations are not recorded.

The time of the day at which the water level will be reset has been set to 0100. You may wish to change this to the Bureau of Meteorology standard of 0900. The level at which the rainfall will be pumped out to prevent overflow has been set to 240mm but can be adjusted.

### 6.2 Preparing To Log Data

Select the 6529E scheme. This can be edited to your logging requirements and saved with your project name. It can then be loaded to your logger and used to log, unload and review data the same as any other Unidata project.

#### 6.2.1 To Adjust The Scheme Details To Suit Your Project

Select System from the toolbar and Scheme Editor from the drop-down menu. Start your Starlog system and a list of schemes will be displayed. Select the 6529E Scheme from the Menu.

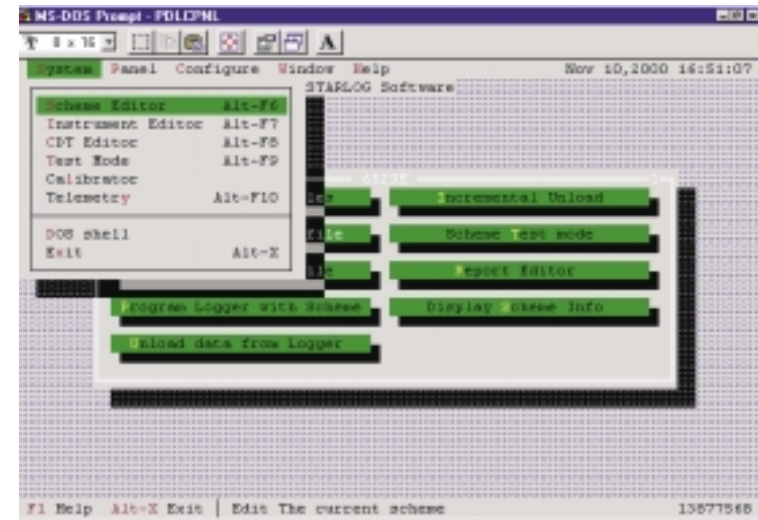

*Selecting the Scheme Editor.*

The following screen will open. You may have to select Window option, then All Options and Tile the Display for the most convenient display. Click on the appropriate box to open it for editing.

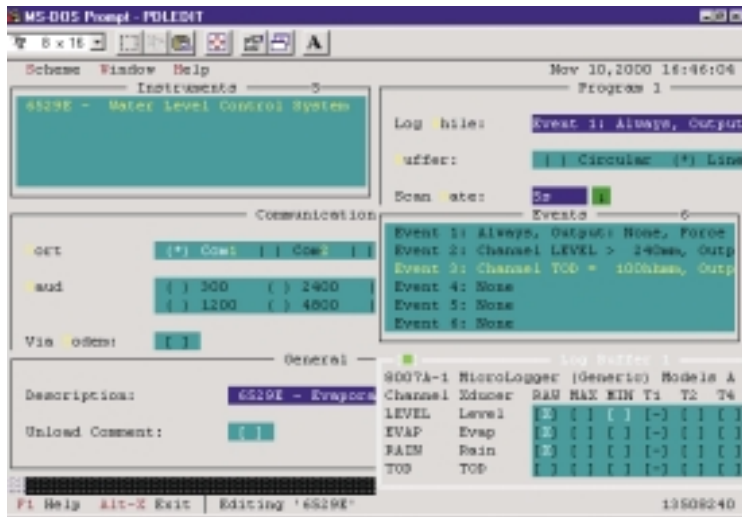

*Displaying Editing Options.*

Select the General Panel to change the description to your site name.

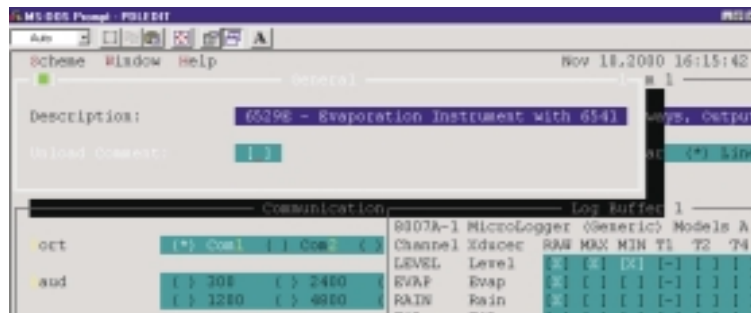

*The General Panel.*

Select the Program Panel to edit the log interval and other details. The following settings are recommended for a normal project. You may prefer a 15 minute log interval to reduce the volume of logged data.

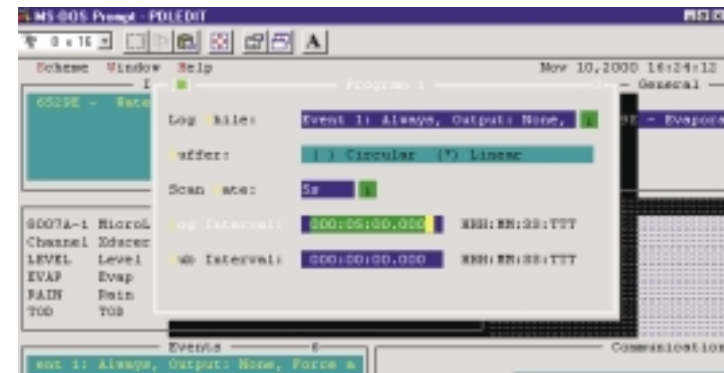

*The Program Panel.*

Click on the Events panel to open the listing of events. Double click on event 3 if you wish to change the reset time. Event 2 sets the level at which rainfall will be drained. Event 3 sets the time at which the daily level reset will start.

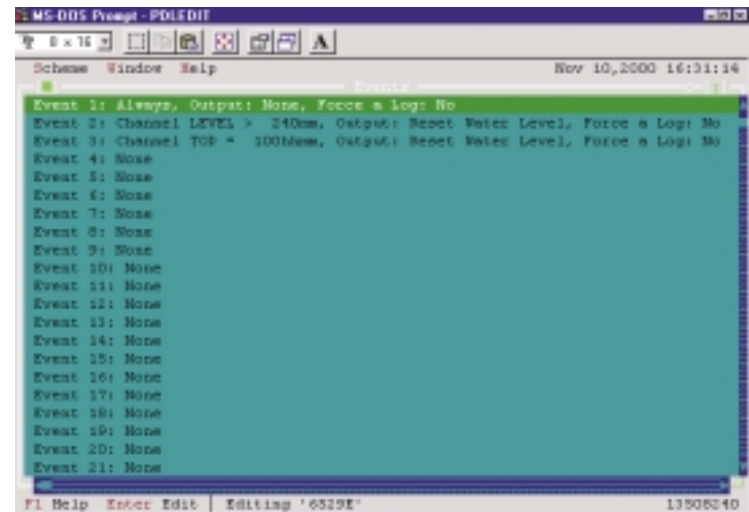

*The Events Panel.*

The events detail box for event 3 will open. This event sets the reset time when  $A=B$ . A is the TOD (Time of Day) and B is the required time. 100 is 1 AM. 1300 is 1 PM. You can change the time and hit OK.

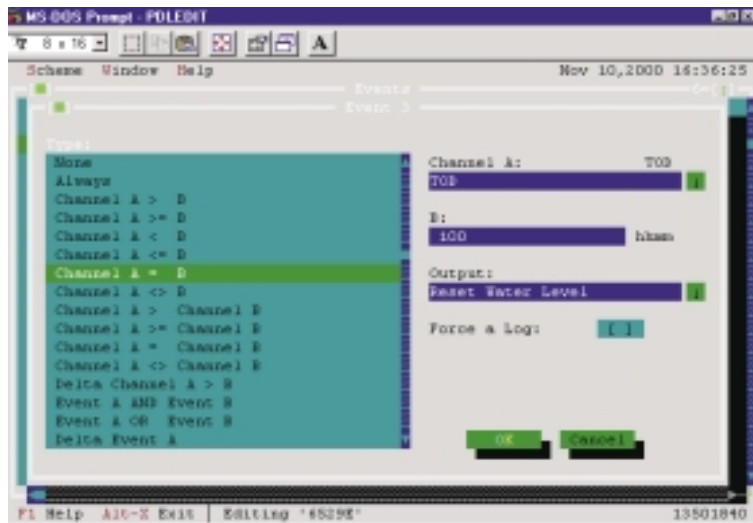

*The Events Detail Panel.*

To select what to log, open the Log Buffer panel. Use the spacebar to select the data you wish to log at each log interval (the spacebar toggles the X on and off).

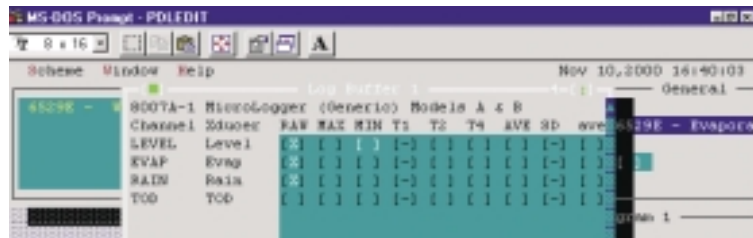

*The Log Buffer Panel.*

When you have finished editing the Scheme, select Scheme from the toolbar, then Save As.

You should save it with a scheme name that identifies your site. This scheme must be used each time you connect to this data logger.

### 6.3 To Start Logging Data

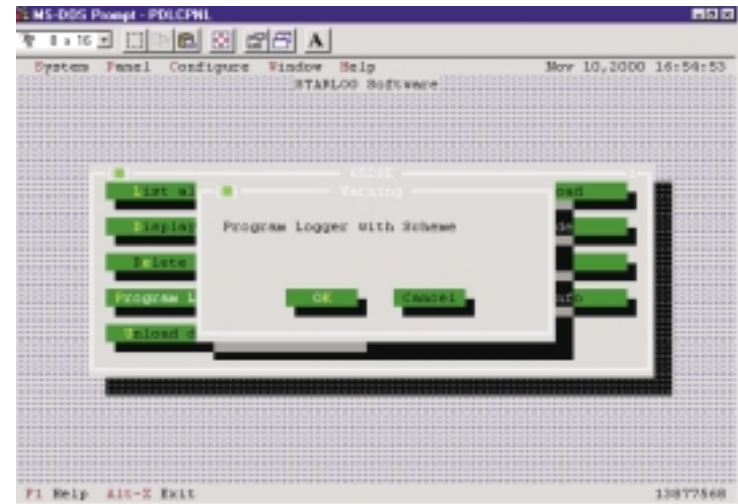

Connect your computer to the data logger using the correct UNIDATA cable and then:

1. Start the STARLOG V3 software.
2. Select the scheme for the site.
3. Select Program logger with scheme.
4. Click OK to continue.

The scheme will be loaded and logging will commence automatically.

## 6.4 To Check Data While Logging Is In Progress

Select Scheme Test Mode from the main menu for the scheme. The screen that appears shows complete details of the current logging situation. The display is updated each scan. You can use this screen as often as you like and for as long as you like; logging continues normally while in Scheme Test Mode.



## 6.5 Data Recovery And Review

Refer to the software manual for Version 3 Software for detailed descriptions on operating the software and displaying data.

Select Display a Data File from the menu. The following screen allows you to select from a range of Reports that you have created, and files you have unloaded.

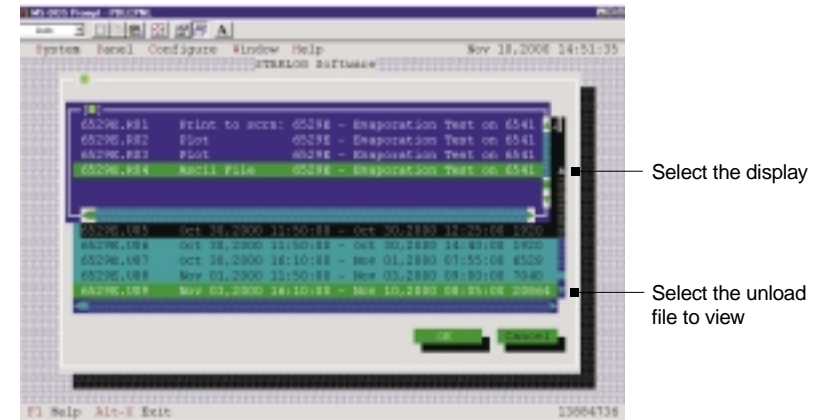

Plots will be displayed as requested, and axes may be expanded and compressed.



An ASCII file, or Lotus file can be created and used with a spreadsheet to further analyse the data.

### 6.5.1 Interpreting Evaporation Data

The following (annotated) graph is an example of typical data from a period, and how it can be interpreted. Three sets of data are logged. The pan water level trace is a full record of all level changes. You can analyse this and extract the evaporation and rainfall data you require. However this has already been done for you, and logged as the evaporation and rainfall data.

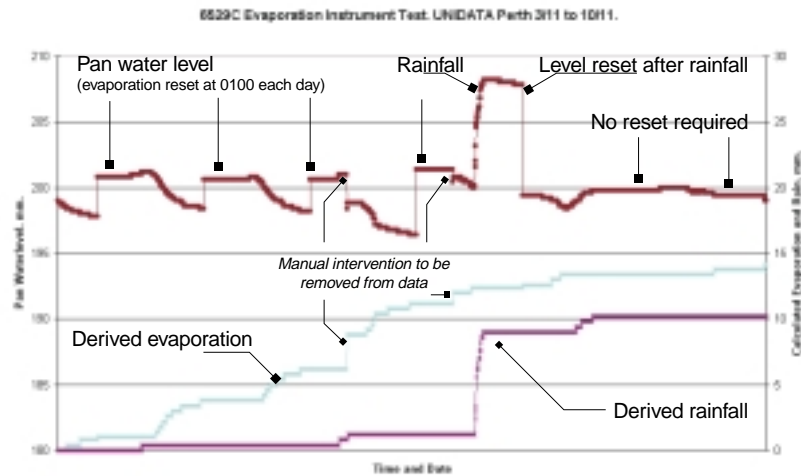

The derived evaporation and rainfall data is the accumulated total since the logger was last reset. It may contain corrupting events if there has been any artificial water level changes. There are two shown in the above example. These can be removed by editing the data in a spreadsheet or with one of a range of commercial editing systems.

*This page intentionally left blank.*

## 7 SITE VISITS AND MAINTENANCE

The purpose of installing the site is to obtain a continuous and reliable record of pan evaporation. This data may be used for a range of process, management and environmental purposes, sometimes in unexpected ways. It is important that the site be operated to a consistent standard by staff with a basic understanding of data collection and management.

Although the equipment can operate for up to 1 year, the site may deteriorate to an unacceptable condition within a few months. Regular site checks and equipment servicing is essential. The site should be inspected and serviced at least monthly. The purpose of the site inspection is to check that the present data is accurate and that this will continue. Experienced site operators prepare for the site visit and use a report form and checklist to record details of the visit. Instrument manuals, documents, site access details, special instructions and visit reports should be kept in a site file, and taken to the site each visit.

Data should be regularly recovered from the site and securely archived in a system that will permanently preserve the raw data. A copy of this data should be reviewed and edited to adjust any anomalies or errors, and saved as an archive for future analysis and use.

### 7.1 Site Visits

#### 7.1.1 Preparing for the Site Inspection

Do the following:

- Check the report from the previous site visit. Prepare to complete any special work that is required.
- Check your computer. Confirm you have an adequate power supply and the correct cable.
- Check and adjust the computer time and date. This will be used to reset the logger.
- Carry any required spare parts and check instruments.
- Take the visit file.

#### 7.1.2 Carrying Out The Site Inspection

At the site your objectives are to:

- Recover the recorded data and verify its quality, and
- Ensure the site will keep operating correctly and the next period of data will be of good quality.

Your common sense will help you achieve this.

At times it will be better to do nothing, and to return another day. For example if it is raining heavily and the site has no protection, you will damage the instruments and your test equipment if they get wet. Rushing through a site visit, or trying to use a faulty computer, can also cause problems.

If you encounter a problem, think logically through the process and carry out checks and tests to eliminate probable causes. It is important to identify the real problem so it can be fixed. Check the most obvious things first. e.g. is your computer connected and operating properly? Is the water supply functional? Do not jump to conclusions.

Do not fiddle with things that are OK. If it is working well, leave it alone.

When you proceed, prepare a comfortable and safe work environment for yourself, lay out the tools and equipment you will need and work through your visit in a logical sequence, such as suggested in the following section. Fill in a report as you go and complete one part of the procedure before proceeding to the next.

#### 7.1.3 Initial Inspection

Before touching anything, inspect and note the condition of the site, installation and instruments.

- Are there any signs of damage or interference?
- Is the pan water level OK?
- Is the water supply functional and sufficient to last to the next inspection?
- Are the instruments clean, dry and secure?
- Is the water level transducer displaying the correct water level?

If you notice any problems try and work out what has happened and how to prevent it reoccurring.

#### 7.1.4 Reviewing The Data

To review the data:

1. Connect your computer to the data logger. Start the STARLOG Version 3 Software.
2. Select the Scheme for the site.
3. Select Scheme Test Mode and review the display of present logging.
4. Note the logger time and date and any difference with real time.
5. Note the water depth in the pan, the transducer display and the logged value.
6. Note the total evaporation and rainfall and the battery voltage.
7. Check the memory remaining, and then estimate the expiry date.
8. Scan the recent data listed. Look for any anomalies that may indicate faults.

#### 7.1.5 Recovering The Data

To recover the data:

1. Select Unload Data from Logger. Data is saved in the Starlog\Schemes folder as name.U##. This is a binary file that can only be interpreted by the Scheme Reports. A Scheme may have many Reports to display and save the data in a variety of ways.
2. Select "Display a Data File". Select the data plot report. Review the logged data for the full period. Look for any unusual data that may indicate a problem with the site or instruments. Zoom the plots for details.
3. Check the general water level record to confirm the timing and level of the resets.
4. Check the detailed shape of the latest daily water level record for unusual periods that may indicate water leaks to or from the pan, or the float system sticking or not functioning correctly.
5. Check that the derived evaporation is sensible, with the expected diurnal variations.

6. Check that the derived rainfall is sensible and supported by the evaporation data.
7. Select the ASCII report. The file will be saved in the Starlog\Schemes folder as name.A##. This is a flat ASCII file sited for spreadsheets and data processing systems.
8. Copy the ASCII file to a disk and leave it at the site, as a backup.

#### 7.1.6 Carry Out Tests And Maintenance

Your data has now been recovered and secured. You can now carry out any checks, tests and maintenance required. This data will be logged, however it will be erased when you reset the logger before you leave. Note on your visit report details of work you have done and maintenance required at the next visit.

See Section 8 for maintenance details.

#### 7.1.7 Resetting the Logger

This is essential if the memory will not last until the next scheduled visit, or if you have disconnected the logger power for any reason. The reset "erases" all previous data and restarts logging. You will have to process the data you have unloaded.

You can choose not to reset the logger. Data logging will continue uninterrupted, and you have secured a back-up copy of the data. When you unload data at your next site inspection you will retrieve all the previous data again, plus the latest data, all a one continuous file. The previous back up can be discarded.

To reset the logger, select Program Logger with Scheme to reset the logger. The reset process is automatic and permanent.

#### 7.1.8 Final Site Check

Use Scheme Test Mode to confirm that logging is underway and that the time and values are correct. Note the information on your visit report. Disconnect the computer and pack away your equipment.



Take a final look at the instruments and site. Confirm that all is operational, clean and in good condition, with sufficient water, battery power and logger memory to last until the next scheduled visit. Close up the instrument cabinet and secure the site. Pick up any rubbish and tidy the area.

## 7.2 Data Processing And Management

This is an essential but sometimes overlooked part of the site operation. Valuable recorded data may be lost or misplaced unless a data processing system is established, documented and used routinely after each site visit. Some sites are operated for many years, and ownership and operators may change. A complete and documented data history is typically kept on a "data processing" file for the site.

The appropriate system will depend on the project. It is possible to manage data from a small number of sites as spreadsheets provided the system is well organised and managed. Larger networks require specialised systems and support.

The only copy of the data is the ASCII file on your computer hard drive. This is why the backup copy has been left at the field site. The original ASCII file should be archived as read-only in a system that is regularly backed up. This should be done immediately you return from the site visit.

This original file may contain anomalies that have to be edited out, and periods of lost or faulty data. Changes are made to a copy of the data (never the original) and comments about what was changed and why, should be appended. Blank periods, or estimates if possible, should be inserted if data has been lost. These changes should be done by, or in consultation with, the site operator.

This edited data should then be appended to previous data to maintain a complete and continuous archive file of all data from the station. Review this file to confirm that the latest data forms a sensible extension to previous data, and that daily and seasonal evaporation and rainfall are sensible.

If apparent data problems are identified during data processing a note should be added to the station visit file, to remind the site operator to attend to the matter at the next site visit. The interaction between site operation, data processing, reporting and review allows for continuous improvement in the quality of the data produced.

## 7.3 Site Maintenance

### 7.3.1 Overview

All evaporation pans need regular maintenance. It is recommended that sites with pans be serviced at least once a month. Dust and debris will accumulate in the pan and algae can grow in some conditions. Leaks can develop and water supplies may need regular maintenance. The recorded data will be effected.

At sites in dry areas a bird guard will prevent water loss from birds and animals drinking from the pan. The guards also reduce the amount of wind borne leaves and debris that lodge in the pan.

The water in the pan should be reasonably clear and clean. If algae growth is excessive a commercial algaecide such as used for swimming pools, may be added to the pan and supply tank

### 7.3.2 Site Surrounds

At fenced sites the vegetation and ground conditions inside the compound should be similar to those outside. Keep any bushes and grass around the pan trimmed to a level below the pan rim. Bushes further away should not be higher than 25% of the distance from the pan. Any fence should be of an open design with minimum wind resistance.

### 7.3.3 Evaporation Pan and Level Monitoring System

The evaporation pan will require regular cleaning. The colour of the interior surface, the water clarity and the amount of surface litter, all affect the recorded evaporation. The frequency of cleaning will depend on site and seasonal conditions. The objective is to keep the pan reasonable clean throughout the year.

Floating material and debris may be scooped out with a small swimming pool net. Clean any dust and debris from inside the pan. The walls and bottom of the pan can be brushed and the water swirled into a "whirlpool". Loose material will accumulate in the centre of the pan and can be vacuumed off with a siphon hose. If there is plenty of water at the site it may be simpler to drain, clean and refill the pan.

Inspect all hoses and fittings, and the stillwell assembly, for signs of leaks. Repair any problems.

#### **7.3.4 Input Water Supply**

There is a water filter between the solenoid and the input water supply hose. This is to intercept any fine debris that may prevent the solenoid from closing. The filter should be checked regularly. It may be removed, washed and replaced. How often this will be required will depend on the quality of the water supply.

To clean or change the filter:

1. Open the enclosure and grasp the body of the filter.
2. Unscrew the filter cap located on the outside of the enclosure.
3. Remove, clean and replace the filter element.
4. Reassemble the system and check for leaks.

#### **7.3.5 Solenoid/Pump**

Regularly check the operation of the solenoid and pump. To check the condition and serviceability of the solenoid and/or pump:

1. Connect each device to the TEST position of the control module. It should turn on and operate continuously.
2. Measure the water flow from each device by timing the flow into the volumetric flask.
3. Compare the flow test results with previous checks. A significant reduction in the flow rate will indicate the need for cleaning, or replacement.
4. Check that the solenoid does not leak in the off position.

Service kits for solenoids are available from Goyen Valves or UNIDATA. Spare pumps can be obtained from UNIDATA. A spare solenoid and pump, or service kits, should be kept at the site ready for use.

*This page intentionally left blank.*